

# Electronic-Key-System

Manual

EKS and EKS FSA

with PROFINET IO interface

Compact from V3.X.X

Modular from V1.1.X

Order no. 2516210



**EKS**   
**PROFINET**



**EUCHNER**

More than safety.

## Table of contents

<b>1</b>	<b>General notes</b>	<b>4</b>
1.1	Use of the manual	4
1.1.1	Explanation of symbols	4
1.1.2	Abbreviations	5
1.2	CE conformity	5
1.3	Approvals	5
1.4	Correct use	6
1.5	Obligations on the operating organization	6
<b>2</b>	<b>Safety precautions</b>	<b>7</b>
<b>3</b>	<b>Function</b>	<b>8</b>
3.1	Functional description	8
3.1.1	Common functions of EKS Standard and version EKS <i>FSA</i>	8
3.1.2	Additional functions of the version EKS <i>FSA</i>	9
<b>4</b>	<b>Technical data</b>	<b>10</b>
4.1	Dimension drawing of compact Electronic-Key adapter	10
4.1.1	Version EKS-A-IIX-G01-ST02/03 with PROFINET interface	10
4.1.2	Version EKS-A-IIXA-G01-ST02/03/04 (EKS <i>FSA</i> ) with PROFINET interface	10
4.2	Dimension drawing of FHM Electronic-Key adapter modular	11
4.3	Dimension drawing of PROFINET modular interface adapter	11
4.4	Technical data for compact version	12
4.5	Technical data for modular version	13
4.6	Connector assignment	14
4.6.1	Connection socket for PROFINET interface	14
4.6.2	Connection terminal assignment for compact version	14
4.6.3	Connection terminal assignment for modular version	15
4.7	DIP switch settings	16
4.7.1	DIP switch S1	16
4.7.2	DIP switch S2	17
4.7.3	DIP switch S3	17
4.8	Indicator LED of compact version	18
4.9	Indicator LEDs of modular version	18
<b>5</b>	<b>Mounting</b>	<b>19</b>
5.1	Electronic-Key adapter compact	19
5.2	Electronic-Key adapter FHM	19
<b>6</b>	<b>Electrical connection</b>	<b>20</b>
6.1	PROFINET connection	21
6.1.1	PROFINET configuration	21
6.2	Connection of power supply	22

6.3 Connection of function earth .....22

6.4 Connection of the semiconductor switching contacts (for EKS *FSA* only) .....22

**7 Setup .....23**

7.1 Requirements .....23

7.2 Configuration settings .....24

7.2.1 Modules available in the GSD file for reading data .....24

7.2.2 Properties for the modules for reading data .....24

7.2.3 Modules available in the GSD file for writing data .....25

7.2.4 Properties for the modules for writing data .....25

7.3 Connecting the EKS to a PROFINET CPU .....26

**8 Operation in the PROFINET .....31**

8.1 Communication .....31

8.2 EKS alarms .....31

8.3 Read/write operation .....32

8.3.1 Input area (read process) .....32

8.3.2 Output area (write process) .....33

**9 Analysis and assignment of DCP name via web interface .....34**

9.1 Network settings for a configuration PC with Windows® .....34

9.2 Configuring the read/write station via the web interface .....37

9.3 Reading Electronic-Key data using the web interface .....39

**10 Exclusion of liability and warranty .....40**

**11 Service and repair .....40**

# 1 General notes

## 1.1 Use of the manual

This manual describes the technical features and the function of the EKS PROFINET read/write stations listed below (also referred to as "devices" for short in the rest of the document).

With the compact version, the Electronic-Key adapter and the evaluation and interface electronics for data transmission are accommodated completely in one housing:

- ▶ Compact Electronic-Key adapter EKS-A-IIX-G01-ST02/03 (order no. 106305) with PROFINET interface from V3.X.X
- ▶ Compact Electronic-Key adapter EKS-A-IIXA-G01-ST02/03/04 (order no. 106306) with PROFINET interface from V3.X.X; version *FSA* (**F**or **S**afety **A**pplications)

With the modular version, the Electronic-Key adapter and the interface adapter with the evaluation and interface electronics for data transmission are accommodated in two separate housings:

- ▶ Modular Electronic-Key adapter EKS-A-SFH... in combination with modular interface adapter EKS-A-AIX-G18 (order no. 122352) with PROFINET interface from V1.1.X
- ▶ Modular Electronic-Key adapter EKS-A-SFH... in combination with modular interface adapter EKS-A-AIXA-G18 (order no. 122353) with PROFINET interface from V1.1.X; version *FSA* (**F**or **S**afety **A**pplications)

### 1.1.1 Explanation of symbols

The following symbols are used in this manual to identify important instructions and useful information:

**Danger!**

Identifies an immediate hazard. If not avoided, the consequence will be fatality or very serious injuries.

**Warning!**

Identifies a possible hazard. If not avoided, the consequence may be fatality or very serious injuries.

**Caution!**

Identifies a possible hazard. If not avoided, minor injuries or damage may result.

**Attention!**

Risk of damage to material or machine or degradation of function.

**Information!**

Important information is provided to the user here.

### 1.1.2 Abbreviations

The following abbreviations are used in this manual:

- ▶ **DCP**        Discovery and **C**onfiguration **P**rotocol
- ▶ **DIP**        Dual **I**nline **P**ackage
- ▶ **E<sup>2</sup>PROM**    Electrically **E**rasable **P**rogrammable **R**ead-Only **M**emory
- ▶ **EKS**        Electronic-**K**ey-**S**ystem
- ▶ **EKS FSA**    Electronic-**K**ey-**S**ystem **F**or **S**afety **A**pplications
- ▶ **FHM**        Front **H**ook **M**odular
- ▶ **GSD**        Geräte **S**tammdat<sup>e</sup>n (device data)
- ▶ **GSDML**    **G**eneric **S**tation **D**escription **M**arkup **L**anguage (special XML file with device parameters for configuration in the control system)
- ▶ **LED**        Light **E**mitting **D**iode
- ▶ **LSB**        Least **S**ignificant **B**it
- ▶ **MSB**        Most **S**ignificant **B**it
- ▶ **PA**         Poly**A**mide
- ▶ **RD**         Receive **D**ata
- ▶ **ROM**        Read-Only **M**emory
- ▶ **TCP/IP**    Transmission **C**ontrol **P**rotocol / Internet **P**rotocol
- ▶ **TD**         Transmit **D**ata

## 1.2 CE conformity

The EKS devices with PROFINET interface comply with the **EMC Directive** 2004/108/EC (2004/108/EG, 2004/108/CE).

The devices comply with the following European/international standards:

- ▶ EN 55011        Industrial, scientific and medical equipment - Radio frequency disturbance characteristics - Limits and methods of measurement
- ▶ EN 61000-6-2    Electromagnetic compatibility (EMC) - Part 6-2: Generic standards - Immunity for industrial environments

## 1.3 Approvals

The EKS devices with PROFINET interface are certified in accordance with c  (UL file number E240367).

For use and operation as per the c  requirements, a power supply with the feature "**for use in class 2 circuits**" must be used.

## 1.4 Correct use

As part of a higher-level overall system, the EKS read/write station is used for access control and monitoring on control systems or parts of control systems for machine installations. EKS can be used, for example, as part of an overall system for checking access rights on the selection of the operating mode. However, it is not permitted to derive the operating mode directly from the access rights on the Electronic-Key. If the selection of the operating mode is relevant for safety, this must not be performed by means of the EKS; instead an additional device must be used to select the operating mode.

### Information!



The Machinery Directive 2006/42/EC provides information on selection of the operating mode. It is imperative that this information be followed.

When designing machines and using the read/write station, the national and international regulations and standards specific to the application must be observed, e.g.:

- ▶ EN 60204, Safety of machinery - Electrical equipment of machines
- ▶ EN 12100-1, Safety of machinery - Basic concepts, general principles for design - Part 1: basic terminology, methodology
- ▶ EN 62061, Safety of machinery - Functional safety of safety-related electrical, electronic and programmable electronic control systems
- ▶ EN ISO 13849-1, Safety of machinery - Safety related parts of control systems - Part 1: General principles for design

Modifications to the electronics of the read/write station and any other changes, especially mechanical modifications and reworking, are not permissible and will result in the loss of the warranty and exclusion of liability.

The read/write station must be employed and used only in accordance with

- ▶ this manual and
- ▶ other documentation referred to in this manual.

The EKS read/write station is not a safety component in the sense of the Machinery Directive.

Without additional precautions the EKS read/write station must not be used to provide a safety function, particularly if failure or malfunction of the device could endanger the safety or health of people in the operating area of a machine.

## 1.5 Obligations on the operating organization

The manufacturer and the organization operating the higher-level overall system, e.g. a machine installation, are responsible for the observance of national and international safety and accident prevention regulations applicable in the specific case.

## 2 Safety precautions

**Warning!**

The EKS read/write station is not a safety component in the sense of the Machinery Directive. Without additional precautions the read/write station must not be used to provide a safety function, particularly if failure or malfunction of the device could endanger the safety or health of people in the operating area of a machine. On this topic, pay particular attention to the sections *Correct use* (see chapter 1.4) and *Electrical connection* (see chapter 6).

**Warning!**

Mounting and electrical connection are allowed to be performed only by authorized personnel who are familiar with the applicable regulations on accident prevention and have read and understood this manual.

Furthermore, installation and electrical connection of the version EKS *FSA* must be performed only by personnel familiar with handling safety components.

**Caution!**

Modifications to the electronics of the read/write station and any other changes, especially mechanical modifications and reworking, are not permissible and will result in the loss of the warranty.

## 3 Function

### 3.1 Functional description

#### 3.1.1 Common functions of EKS Standard and version EKS FSA

The EKS is used for access control and monitoring on control systems or parts of control systems for machine installations.

Instead of passwords, coded Electronic-Keys are assigned. In this way unauthorized access to control and display systems is prevented to the greatest possible extent.

The EKS uses a non-contact, inductive read/write identification system.

It consists at least of:

- ▶ Electronic-Key
- ▶ Electronic-Key adapter EKS compact or Electronic-Key adapter FHM with interface adapter EKS modular

The user is responsible for organizing the programming of the application, integration into an overall system and the assignment and use of the freely programmable memory in the Electronic-Key.

#### Information!



For easier organization and management of your Electronic-Keys and the data they contain, EUCHNER also offers the Electronic-Key-Manager (EKM) software. To enter data in the EKM software, an Electronic-Key adapter with serial interface or USB interface must be in operation on the PC.

EKS PROFINET devices are read/write systems with electronics for the inductive bidirectional interface to the transponder and interface electronics.

Due to the non-contact transfer of data, the Electronic-Key adapter is designed with a high degree of protection suitable for industry from the access side. The Electronic-Key adapter is fastened from the rear side of the panel in order to exclude unauthorized tampering from the operator side.

The system is connected via the integrated PROFINET interface, which is designed as an RJ45 socket. A separate switch may be required for the PROFINET connection. The device does not have an integrated switch.

Setup and system integration can be realized straightforwardly and quickly on the read/write station with PROFINET interface.

The current state of the Electronic-Key adapter is displayed using a 3-color LED.

The Electronic-Key is placed on the Electronic-Key adapter for operation. The power supply for the transponder and the data are transferred between the Electronic-Key adapter and the Electronic-Key without using any contacts.



Figure 1: Cut-away illustration of an Electronic-Key adapter with Electronic-Key in the compact version



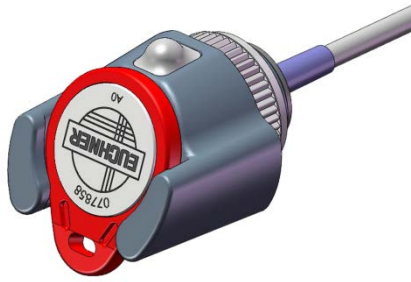

Figure 2: Illustration of an Electronic-Key adapter with Electronic-Key in the modular version

The Electronic-Keys are tag shaped. The complete transponder with memory chip and antenna is integrated into the Electronic-Key. The transponder does not have a battery.

The data carrier in the Electronic-Key is equipped with a combined memory:

- ▶ 116 bytes E<sup>2</sup>PROM (programmable) plus 8 bytes ROM (serial number)

On Electronic-Keys read/write with 116 bytes, the memory is organized in 4-byte blocks. This means a multiple of 4-byte sized blocks must always be written.

### 3.1.2 Additional functions of the version EKS FSA

The version EKS FSA has additional switching contacts (semiconductor relay) that are switched off as long as there is no Electronic-Key in the Electronic-Key adapter or if the Electronic-Key cannot be read.

- ▶ Compact version of the device: switching contacts LA1/LA2 and optionally LB1/LB2
- ▶ Modular version of the device: only switching contact LA1/LA2

The switching contacts are electrically isolated from the device electronics and from each other. Either AC or DC can be switched.

Each of the contacts is operated with diversity by a dedicated processor that opens the contacts on removal of the Electronic-Key (see figure Block diagram EKS FSA).

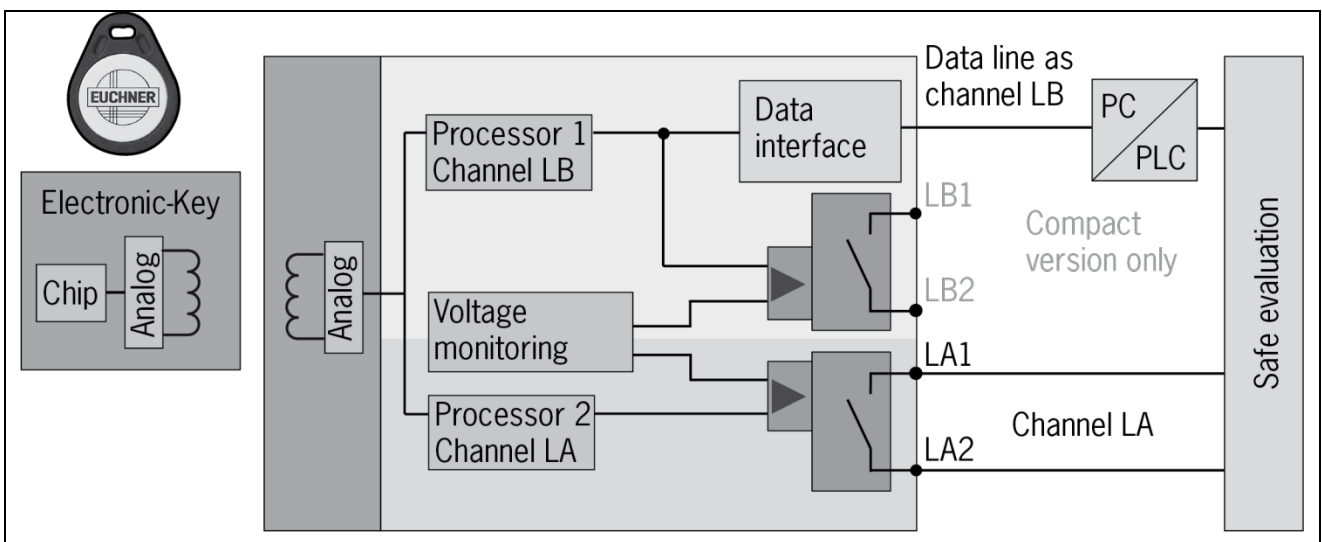

Figure 3: Block diagram EKS FSA

Due to separate evaluation of channel LA and channel LB, the EKS FSA device can be used in conjunction with a safe evaluation device in safety-related applications. Integrated voltage monitoring switches off the switching contacts LA and LB if the power supply is outside the permitted tolerance (see chapters 4.4 and 4.5).



**Information!**

The switching contacts FSA close when the Electronic-Key is in place, irrespective of the data allocation in the memory.

## 4 Technical data

### 4.1 Dimension drawing of compact Electronic-Key adapter

For installation in a control panel you must provide a cut-out 33 mm x 68 mm according to DIN 43700.

#### 4.1.1 Version EKS-A-IIX-G01-ST02/03 with PROFINET interface

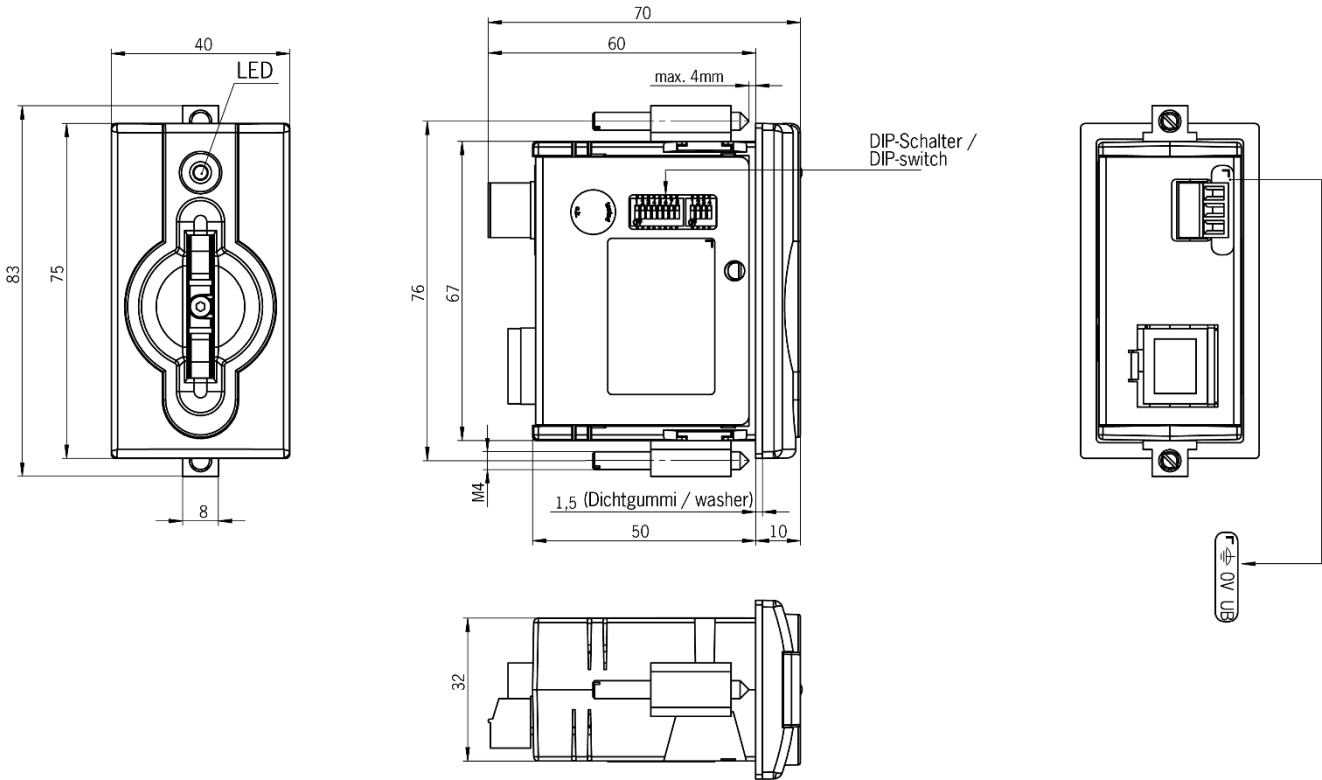

#### 4.1.2 Version EKS-A-IIXA-G01-ST02/03/04 (EKS FSA) with PROFINET interface

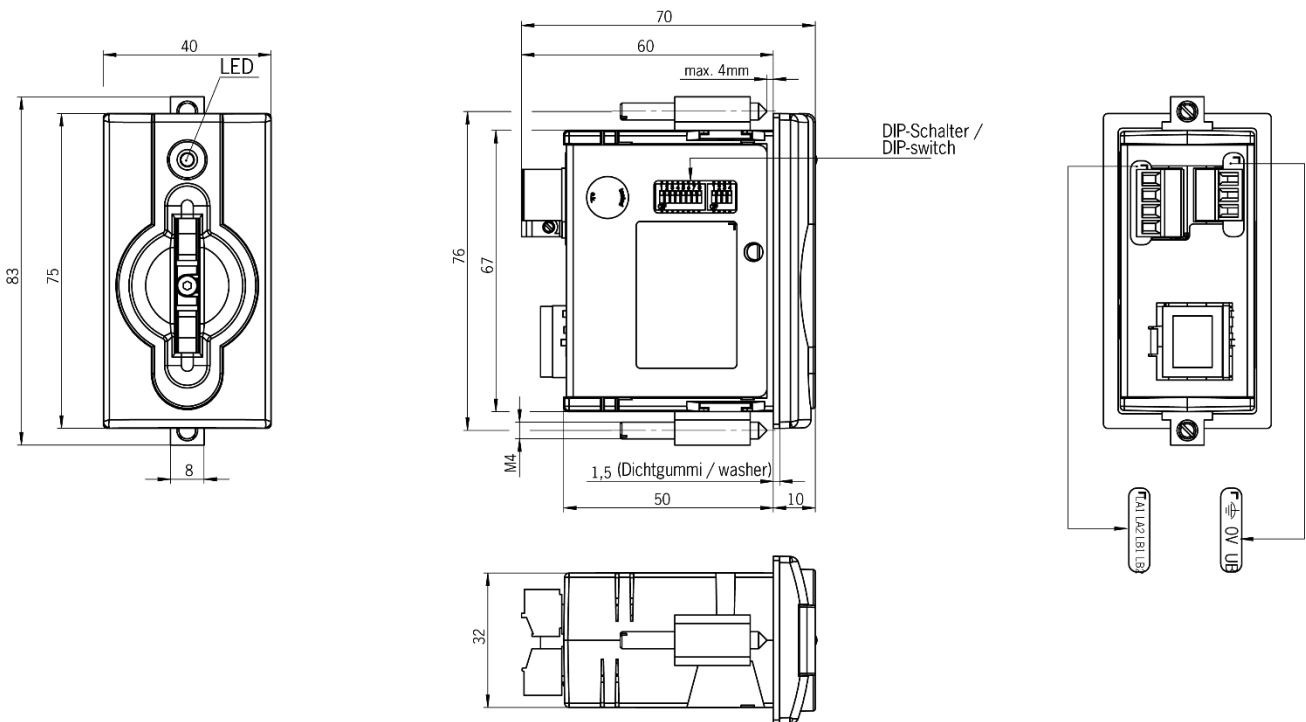

### 4.2 Dimension drawing of FHM Electronic-Key adapter modular

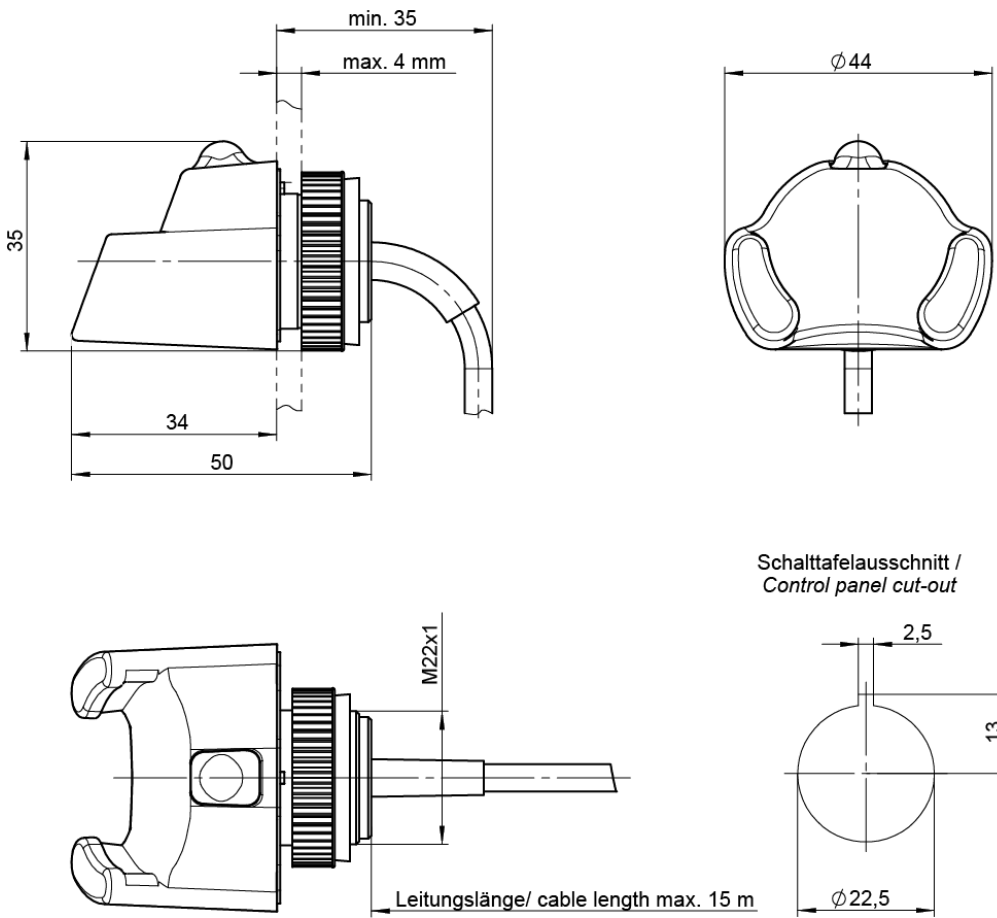

### 4.3 Dimension drawing of PROFINET modular interface adapter

passend für Hutschiene 35 mm nach DIN EN 60715 TH35 /  
suitable for rail 35 mm acc. to DIN EN 60715 TH35

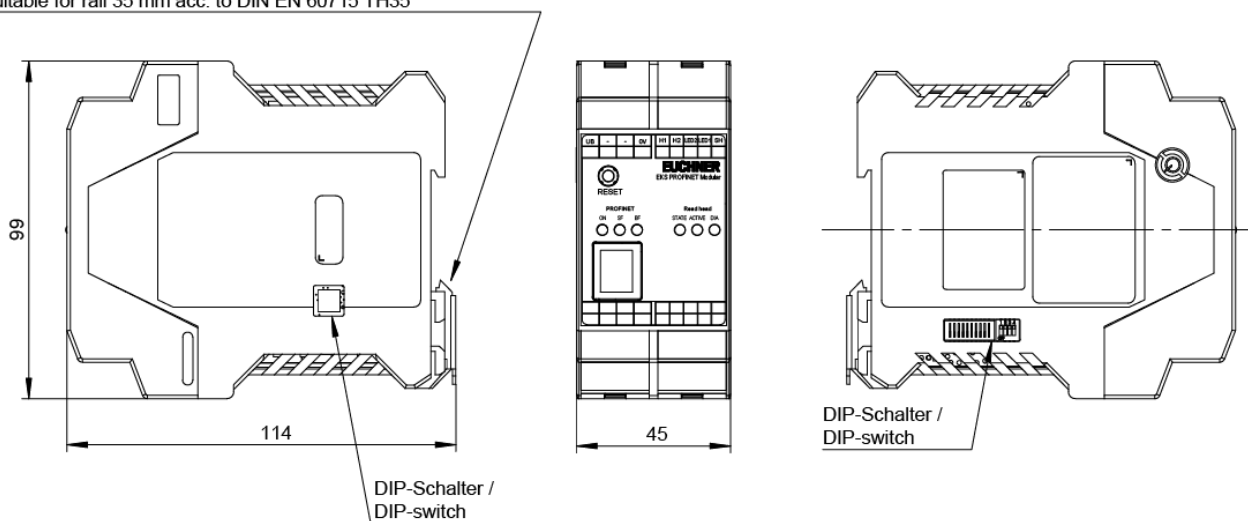

## 4.4 Technical data for compact version

### Attention!

- ! All the electrical connections must either be isolated from the mains supply by a safety transformer according to IEC 61558-2-6 with limited output voltage in the event of a fault, or by other equivalent isolation measures.

General parameters	Value			Unit
	min.	typ.	max.	
Housing	Plastic (PA 6 GF30 gray)			
Degree of protection acc. to EN 60529	IP 67 in mounted condition			
Ambient temperature at $U_B = DC 24 V$	0		+ 55	°C
Mounting cut-out acc. to DIN 43700	33 x 68			mm
Power supply connection	Plug-in connection terminal, 3-pin, with screw terminal (tightening torque 0.22 Nm), conductor cross-section 0.14 ... 1.5 mm <sup>2</sup>			
Operating voltage $U_B$ (regulated, residual ripple < 5 %)	20	24	28	DC V
Current consumption $I_B$			150	mA
<b>Interface, data transfer</b>				
Interface to the control system	Industrial Ethernet (IEEE 802.3)			
Transfer protocol	PROFINET acc. to IEC 61158 / IEC 61784-1 and -2			
Data transfer rate (full duplex)		10/100		Mbit/s
Connection for Ethernet interface	1 x RJ45 socket			
Data line	2 x 2 twisted-pair copper cables, screened; min. category 5			
Cable length			100	m
LED indicator	Green: "Ready" (in operation) Yellow: "Electronic-Key active" * Red: "Error"			
<b>Version FSA (For Safety Applications) - parameters for floating semiconductor switching contacts LA and LB</b>				
Switching contact connection	Plug-in connection terminal, 4-pin, with screw terminal (tightening torque 0.22 Nm), conductor cross-section 0.14 ... 1.5 mm <sup>2</sup>			
Power supply $U$ for load (LA, LB)		24	30	V
Switching current (with overload protection)	1	10	50	mA
Output voltage $U_A$ (LA, LB) in switched state	$U \times 0.9$		$U$	V
Resistance in switched state		35		ohms
Capacitive load			1	µF
Utilization category according to EN IEC 60947-5-2	AC-12 AC-15 DC-12 DC-13	50 mA / 24 V		
Difference time of the outputs** (LB first)		200		ms
<b>Reliability values according to EN ISO 13849-1 (FSA version only)</b>				
Category (with downstream safe evaluation)	3			
MTTF <sub>D</sub> Evaluation of data channel and one switching contact LA	416			years
Evaluation of data channel and both switching contacts LA and LB	803			years
DC	92			%

\* The LED illuminates yellow if there is a functional Electronic-Key in the Electronic-Key adapter.

\*\* If the Ethernet interface is accessed during placement or removal of the Electronic-Key, the difference time can be more than 200 ms.

## 4.5 Technical data for modular version

### Attention!

- ! All the electrical connections must either be isolated from the mains supply by a safety transformer according to IEC 61558-2-6 with limited output voltage in the event of a fault, or by other equivalent isolation measures.

General parameters	Value			Unit
	min.	typ.	max.	
<b>General parameters of Electronic-Key adapter Front Hook Modular FHM</b>				
Housing	Plastic (PVDF GF30, gray)			
Degree of protection acc. to EN 60529	IP 65, IP 67, IP 69K in installed state			
Ambient temperature	-20		+70 / +100*	°C
Mounting bore	Ø 22.5			mm
Connection	Connection cable permanently connected to Electronic-Key adapter or with plug connector in the cable, with flying lead			
Connection cable length	2, 5, 10, 15			m
Connection cable cross-section	4 x 0.25 screened			mm <sup>2</sup>
Connection cable outer sheath	PVC			
<b>General parameters of modular interface adapter</b>				
Housing	Plastic (PA 6.6, gray)			
Ambient temperature at U <sub>B</sub> = DC 24 V	0		+55	°C
Installation	35-mm mounting rail acc. to DIN EN 60715 TH35			
Number of connectible Electronic-Key adapters	1			
Connection for power supply and Electronic-Key adapter	Plug-in connection terminals, 4-pin and 5-pin, with screw terminal (tightening torque 0.22 Nm) or spring terminal, conductor cross-section 0.2 ... 1.5 mm <sup>2</sup>			
Cable length to Electronic-Key adapter		2	15	m
Operating voltage U <sub>B</sub> (regulated, residual ripple < 5 %)	20	24	28	DC V
Current consumption I <sub>B</sub>			150	mA
<b>Interface, data transfer</b>				
Interface to the control system	Industrial Ethernet (IEEE 802.3)			
Transfer protocol	PROFINET acc. to IEC 61158 / IEC 61784-1 and -2			
Data transfer rate (full duplex)		10/100		Mbit/s
Connection for Ethernet interface	1 x RJ45 socket			
Data line	2 x 2 twisted-pair copper cables, screened; min. category 5			
Cable length			100	m
Read head LED indicator	Green (STATE): "Ready" (in operation) Yellow (ACTIVE): "Electronic-Key active" ** Red (DIA): "Error"			
PROFINET LED indicator	Green (ON): "Active" Red (SF): "Collective error" Red (BF): "Bus error"			
<b>Version FSA (For Safety Applications) - parameters for floating semiconductor switching contact LA</b>				
Switching contact connection	Plug-in connection terminal, 5-pin, with screw terminal (tightening torque 0.22 Nm) or spring terminal, conductor cross-section 0.2 ... 1.5 mm <sup>2</sup>			
Power supply U for load (LA)		24	30	V
Switching current (with overload protection)	1	10	50	mA
Output voltage U <sub>A</sub> (LA) in switched state	U x 0.9		U	V
Resistance in switched state		35		ohms
Capacitive load			1	µF
Utilization category according to EN IEC 60947-5-2	AC-12 AC-15 DC-12 DC-13	50 mA / 24 V		
<b>Reliability values according to EN ISO 13849-1 (FSA version only)</b>				
Category (with downstream safe evaluation)	3			
MTTF <sub>D</sub> Evaluation of data channel and one switching contact LA	416			years
DC	92			%

\* This is not an ambient temperature for operation. It is valid for a time of no more than 3 minutes, e.g. for cleaning purposes.

\*\* The LED illuminates yellow if there is a functional Electronic-Key in the Electronic-Key adapter

## 4.6 Connector assignment

### 4.6.1 Connection socket for PROFINET interface

The connection on the Electronic-Key adapter is realized as an RJ45 (8P8C) socket corresponding to ISO IEC 61754-24.

Pin	Function
1	Transmit Data + (TD+)
2	Transmit Data - (TD-)
3	Receive Data + (RD+)
6	Receive Data - (RD-)

### 4.6.2 Connection terminal assignment for compact version



**Information!**

The plug-in connection terminals are included with the Electronic-Key adapter.

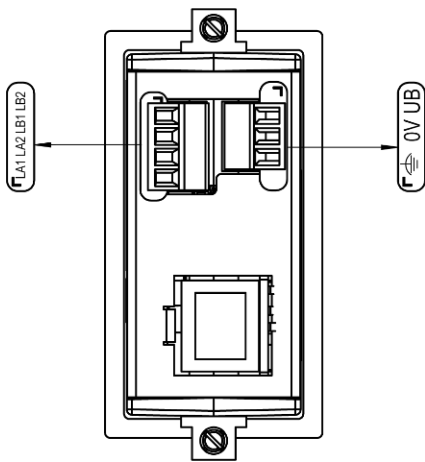

#### 4.6.2.1 Connection of power supply

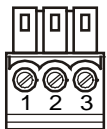

Plug-in connection terminal, 3-pin, with screw terminal

Pin	Designation	Function
1	UB	Power supply DC + 24 V
2	0V	Power supply DC 0 V
3	Function earth	Electrically connected to the housing

#### 4.6.2.2 Connection of switching contacts LA1/LA2 and LB1/LB2 (EKS FSA only)

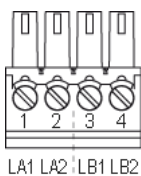

Plug-in connection terminal, 2 x 2-pin, with screw terminal

Pin	Channel	Function
1	LA	NO contact, channel LA
2		
3	LB	NO contact, channel LB
4		

**4.6.3 Connection terminal assignment for modular version**



**Information!**

The plug-in connection terminals are not included with the interface adapter

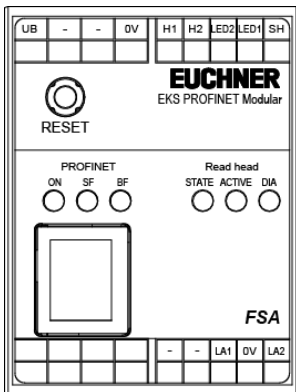

**4.6.3.1 Connection to Electronic-Key adapter**

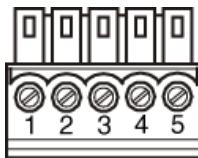

Plug-in connection terminal, 5-pin, with screw terminal or spring terminal

Pin	Designation	Function	Conductor coloring
1	SH	Shield of FHM Electronic-Key adapter	BK
2	LED1	LED of FHM Electronic-Key adapter	YE
3	LED2	LED of FHM Electronic-Key adapter	GN
4	H2	Antenna of FHM Electronic-Key adapter	WH
5	H1	Antenna of FHM Electronic-Key adapter	BN

**4.6.3.2 Connection of power supply**

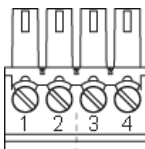

Plug-in connection terminal, 4-pin, with screw terminal or spring terminal

Pin	Designation	Function
1	0V	Power supply DC 0 V
4	UB	Power supply DC + 24 V

**4.6.3.3 Connection of switching contact LA1/LA2 (EKS FSA only)**

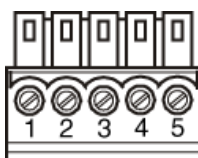

Plug-in connection terminal, 5-pin, with screw terminal or spring terminal

Pin	Designation	Function
1		
2		
3	LA1	NO contact, channel LA
4	0V	
5	LA2	

## 4.7 DIP switch settings

The device has three DIP switches (S1, S2, S3).

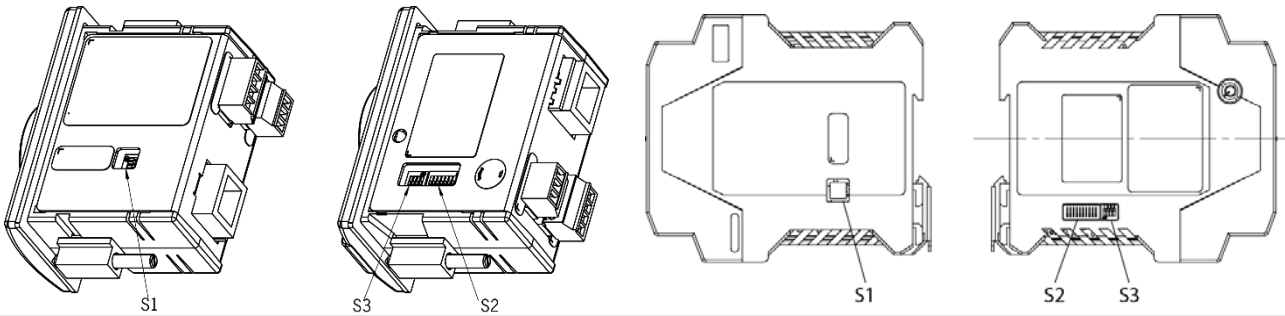

### Compact device

DIP switch	Function
S1 (4-fold)	S1.1 ... S1.4; write and read settings
S2 (8-fold)	S2.1 ... S2.8; setting of a fixed DCP name (depending on the setting for S3)
S3 (4-fold)	S3.1 ... S3.4; settings for network connection and service

### Modular device

DIP switch	Function
S1 (4-fold)	S1.1 ... S1.4; write and read settings
S2 (10-fold)	S2.1 ... S2.10; setting of a fixed DCP name (depending on the setting for S3)
S3 (4-fold)	S3.1 ... S3.4; settings for network connection and service



#### Information!

The settings are adopted only when the power supply is switched on.

### 4.7.1 DIP switch S1

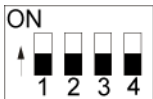

DIP switch	Function	Factory setting
S1.1	ON = write protection for Electronic-Key read/write	OFF
S1.2	Internal function	OFF
S1.3	Internal function	OFF
S1.4	Internal function	OFF



#### Information!

It is **imperative** that all switches without a function (S1.2, S1.3 and S1.4) are set to **OFF**! In this way problems with any functions added in the future will be avoided.



### 4.7.2 DIP switch S2

**Information!**



To be able to define the DCP name using DIP switch S2, all of DIP switch S3 must first be set to OFF. The use of the switches to assign the DCP name and the IP address is described in the following in chapter 6.1.1.

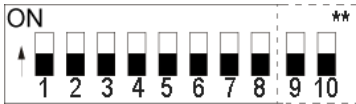

DCP name	LSB							MSB			
	S2.1	S2.2	S2.3	S2.4	S2.5	S2.6	S2.7	S2.8	S2.9**	S2.10**	
Adopt from configuration software*	OFF	OFF	OFF	OFF	OFF	OFF	OFF	OFF	OFF	OFF	
EKS-PN-1	ON	OFF	OFF	OFF	OFF	OFF	OFF	OFF	OFF	OFF	
EKS-PN-2	OFF	ON	OFF	OFF	OFF	OFF	OFF	OFF	OFF	OFF	
EKS-PN-3	ON	ON	OFF	OFF	OFF	OFF	OFF	OFF	OFF	OFF	
...	...	...	...	...	...	...	...	...	...	...	
EKS-PN-254	OFF	ON	ON	ON	ON	ON	ON	ON	OFF	OFF	
EKS-PN-255	ON	ON	ON	ON	ON	ON	ON	ON	OFF	OFF	

\* The name that was last set in the configuration software is used (factory setting: all in OFF position)

\*\* Present only on modular interface adapter. Internal function. Retain default setting.



**Information!**

If a DCP name is set on DIP switch S2, a name set previously will be overwritten.

### 4.7.3 DIP switch S3

Using DIP switch S3, you define the way the device is to receive its DCP name.

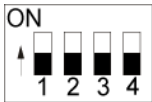

Function	S3.1	S3.2	S3.3	S3.4
Assign DCP name via the configuration software or set it via DIP switch S2	OFF	OFF	OFF	OFF
Set DCP name via the web interface	ON	OFF	OFF	OFF
Set default IP address	ON	OFF	ON	ON
Internal function, leave switch OFF		OFF		

(Factory setting: all in OFF position)

= any switch position



**Information!**

The use of the switches to assign the DCP name and the IP address is described in the following in chapter 6.1.1.

The IP address is always set automatically via the configuration software and assigned via the DCP CPU.

To prevent unauthorized changes to the network, it is sensible to deactivate the web interface after use. For this purpose switch S3.1 is set to OFF.

### 4.8 Indicator LED of compact version

The Electronic-Key adapter operating states are indicated using a 3-color LED on the front. The illumination of the LED in any color indicates the presence of the operating voltage.

Operating state	Description	Color
Electronic-Key adapter power-up or fault	After the application of the power supply, the LED is constantly illuminated red during power-up. The completion of the process is indicated by a change in this state after approx. 10 seconds. If the LED then remains red, it is an indication of a PROFINET network fault. The LED also remains red during communication via TCP/IP.	Red
Ready	Network connected.	Green
Electronic-Key active	Network connected. Electronic-Key is in the Electronic-Key adapter.	Yellow
Acknowledgment	As soon as the voltage is applied LED flashes red/green. Default IP address is restored.	Red/green

### 4.9 Indicator LEDs of modular version

The operating states of the read/write stations are indicated via LEDs in three colors.

On the FHM Electronic-Key adapter, the state of the identification system is signaled by a single three-color LED. On the interface adapter, the same state is signaled by three individual LEDs (read head) in different colors. The illumination of the LED in any color indicates the presence of the operating voltage.

The state of the data interface is additionally signaled via three individual LEDs in different colors on the interface adapter (PROFINET).

Operating state Description	PROFINET			Read head		
	Green ON	Red SF	Red BF	Green STATE	Yellow ACTIVE	Red DIA
Power-up of the Electronic-Key adapter	flashing (2 Hz)	x*	x	x	x	x
Fault: PROFINET error	on	on	x	x	x	x
Fault: No bus connection with control system	on	x	on	x	x	x
Fault: Error in EKS (no Electronic-Key in place)	on	x	x	flashing	off	flashing
Fault: Error in EKS (Electronic-Key in place)	on	x	x	flashing	flashing	off
Ready: Network connected	on	off	off	on	off	off
Electronic-Key active: Network connected. Electronic-Key is in the Electronic-Key adapter	on	off	off	on**	on	off
Acknowledgment: Default IP address is restored	flashing (1 Hz)	flashing (1 Hz)	flashing (1 Hz)	x	x	x

\* x = Any state

\*\* Only the yellow LED is illuminated on the FHM Electronic-Key adapter

## 5 Mounting



### Warning!

Mounting must be performed only by authorized personnel.

After mounting, again check the Electronic-Key adapter for firm seating and correct sealing on the front panel.

### 5.1 Electronic-Key adapter compact



#### Attention!

To achieve the degree of protection IP 67, it is necessary to install the Electronic-Key adapter in a clean, flat metal plate at least 2 mm thick and to tighten the screws with a tightening torque of 0.25 ... 0.35 Nm.

A suitable strain relief must be provided for the connection cables in order to avoid damage to the connection sockets or malfunctions.

The Electronic-Key adapter is intended for mounting in control panels with a cut-out measuring 33 mm x 68 mm according to DIN 43700 (see section 4.1). The device is fastened using screw clamp elements from the rear side of the panel.



#### Information!

The screw clamp elements for front panel mounting are included with the Electronic-Key adapter.

1. Insert the key adapter, **with seal already bonded in place**, into the mounting cut-out from the front.
2. Insert screw clamp elements in the housing of the Electronic-key adapter from the side up to the stop and tighten with 0.25 ... 0.35 Nm.



#### Attention!

The device may be damaged if the tightening torque exceeds 0.35 Nm.

### 5.2 Electronic-Key adapter FHM



#### Attention!

To achieve the degree of protection IP 69K, it is necessary to install the FHM Electronic-Key adapter in a clean, flat metal plate at least 2 mm thick and to tighten the central fixing nut with a tightening torque of 2 Nm.

A suitable strain relief must be provided for the connection cables in order to avoid damage to the connection sockets or malfunctions.

The Electronic-Key adapter is intended for mounting in control panels with a cut-out  $\varnothing$  22.5 mm (see chapter 4.2).

## 6 Electrical connection

**Danger!**

Electrical connection may be performed only by **authorized personnel trained in EMC** and with the device and wiring **isolated**.

**Warning!**

For use and operation as per the **UL** requirements, a power supply with the feature "**for use in class 2 circuits**" must be used.

**Attention!**

The read/write station is allowed to be connected only if it is electrically isolated. Otherwise the device can be damaged.

**Attention!**

If connected incorrectly, the device can be damaged. Observe electrical characteristics and terminal assignment (see chapter 4.4 Technical data for compact version and chapter 4.5 Technical data for modular version).

**Attention!**

All the electrical connections must either be isolated from the mains supply by a safety transformer according to IEC/EN 61558-2-6 with limited output voltage in the event of a fault, or by other equivalent isolation measures.

**Attention!**

When connecting, the operating organization must ensure compliance with the EMC protection requirements in accordance with EN 55011 and EN 61000-6-2.

**Attention!**

The equipotential bonding system of the machine installation must comply with EN 60204-1, section 8, Equipotential bonding.

**Attention!**

Do not lay connecting cables in the immediate vicinity of sources of interference.

## 6.1 PROFINET connection

The interface for the read/write station is compatible with the standards ISO/IEC 61754-24 and IEC 61158. The device is operated in full-duplex mode with 10 Mbit/s or 100 Mbit/s.



### Information!

- ▶ Only a screened 100 BaseTX cable, twisted pair, Cat 5 or higher, is permitted for use as the connection cable. The maximum cable length is 100 m.
- ▶ It may be necessary to provide additional shielding in conditions with a high level of EMC interference.
- ▶ A separate PROFINET switch may be required for the PROFINET connection.

### 6.1.1 PROFINET configuration

It is necessary to assign a unique DCP name for the unambiguous addressing of a subscriber in the PROFINET network. There is no DCP name saved in the device as the factory setting.

In the first step a DCP name is assigned to the device (see DIP switch settings in chapter 4.7). There exist the following three possibilities:

1. Assignment via the configuration software
2. Assignment via setting of DIP switch S2
3. Assignment via web interface

This DCP name is saved in the device. In the second step the IP address is always set automatically via the configuration software based on the unique DCP name used and assigned via the DCP CPU.

In addition, the following service functions can be set with DIP switch S3:

- ▶ Reset to default IP address (see chapters 4.7.3 and 6.1.1.1)
- ▶ Permit or prohibit configuration via web interface (see chapters 4.7.3 and 9.2)

The individual functions are described below in detail.

#### 6.1.1.1 Default IP address

Each device has the factory-set default IP address 192.168.1.1 and the subnet mask 255.255.255.0.

To reset the device to the default IP address, proceed as follows. The device must be disconnected from the PROFINET network during this routine.

1. Disconnect the device from the power supply.
2. Set switch S3.1, S3.3 and S3.4 (see DIP switch settings in chapter 4.7.3) to ON.
3. Apply power supply. Wait until the device has adopted the default IP address. This situation is indicated by the LED flashing red/green.
4. Disconnect the device from the power supply. Then set all switches of DIP switch S3 to OFF (factory setting) (see chapter 4.7.3).

After the application of the power supply, the device now powers up again with the default IP address. The DCP name is deleted during this process.



### Information!

With the modular interface adapter, the RESET button on the front can be used to disconnect the power supply and restart the device.

### 6.1.1.2 Setting DCP name via DIP switch S2

In this operating mode the DCP name for the EKS is defined by the DIP switch S2. During this process DIP switch S2 defines the suffix for the DCP name EKS-PN-XXX, where XXX can have the values 001 – 255. A prerequisite for this operating mode is that during configuration the DCP name EKS-PN-XXX is used.

#### Information!



With this setting it is also possible to change an EKS easily in case of need for replacement. For this purpose the suffix number for the old EKS is set on the new EKS via DIP switch S2 and the new EKS then fitted.

## 6.2 Connection of power supply

(For the connector assignment, see chapter 4.6.2.1 and 4.6.3.2 Connection of power supply)

It is imperative that the following points are observed:

- ▶ The connections must be made as appropriate to maintain EMC performance.
- ▶ A power supply of suitable EMC performance must be used for the power supply.
- ▶ Conductor cross-section maximum 1.5 mm<sup>2</sup>.
- ▶ Tighten the screws on the terminal plug to 0.22 Nm.



#### Information!

With the modular interface adapter, the RESET button on the front can be used to disconnect the power supply and restart the device.

## 6.3 Connection of function earth

The function earth is connected via terminal 3 on the plug-in screw terminals for the power supply. This connection is electrically connected internally to the housing of the compact Electronic-Key adapter.



#### Information!

The function earth must be connected to PE!

## 6.4 Connection of the semiconductor switching contacts (for EKS FSA only)



#### Warning!

Incorrect connection or errors in the safety-related integration of the EKS FSA can lead to fatal injury. For this reason, observe the following safety aspects:

- ▶ It is not possible to generate a safe signal by using only the switching contacts LA1/LA2 and LB1/LB2. Safe, downstream evaluation is always necessary. Use of the switching contact LB1/LB2 (for the compact version only) is optional.
- ▶ Safe evaluation must always be dual-channel:  
Evaluation of switching contact LA1/LA2 as channel LA together with evaluation of the data line as channel LB.



#### Information!

The switching contact LA1/LA2 is used with functionally safe applications. The function that can be evaluated in terms of safety engineering is the reliable detection that an Electronic-Key has not been placed.

## 7 Setup



### Information!

You will require the corresponding GSD file in GSDML format to integrate the EKS in a PROFINET system environment:

- ▶ GSDML-Vx.x-Euchner-EKS\_3.x.x\_109539-YYYYMMDD.xml
- ▶ GSDML -Vx.x-EUCHNER-EKS\_PN\_modular\_126145-YYYYMMDD.xml

The GSD file is available for download on the Internet at [www.euchner.com](http://www.euchner.com) or free of charge on request. The archive of the GSD file also includes the image file for depicting the device in the configuration software.

Prior to setup, the GSD file must be installed in the configuration software for the control system (see control system manual).

A separate PROFINET switch respectively a patch cable may be required for the PROFINET connection.

Perform setup in the following sequence:

1. Configure EKS with the aid of the GSD file.
2. Set the DIP switches of the device (see chapter 4.7).
3. Check that mounting and electrical connection are correct (see chapter 5 and chapter 6).
4. After the power supply is plugged in, the LED on the front of the compact Electronic-Key adapter is illuminated, or the SF and BF LEDs on the interface adapter are initially illuminated red. Once the connection has been established, the LED on the front of the compact Electronic-Key adapter respectively the ON LED on the interface adapter are illuminated in green and signal readiness for operation.
5. Place the Electronic-Key in the Electronic-Key adapter. The LED on the front of the compact Electronic-Key adapter or the ACTIVE LED on the interface adapter changes to yellow.
6. Important: for the version EKS *FSA*, all safety functions must also be thoroughly tested.

### 7.1 Requirements

You need the following hardware/software to integrate the EKS read/write station into the PROFINET network:

- ▶ Current GSD file for the configuration
- ▶ Configuration software (e.g. SIMATIC STEP 7)
- ▶ PROFINET CPU (e.g. Siemens CPU315)

## 7.2 Configuration settings

This section describes the possible settings for the modules *EKS read* and *EKS write*. In chapter 7.3 Connecting the EKS to a PROFINET CPU it is shown, step-by-step, how the device is configured in the configuration software for the control system.

### 7.2.1 Modules available in the GSD file for reading data

The number of bytes transferred cyclically is defined by the selection of the module in the GSD file. A maximum of 124 bytes user data can be read from the Electronic-Key. The following modules can be selected:

GSD file selection (data block size) Control system input area	Electronic-Key user data read
Read: 009 bytes	8 bytes
Read: 017 bytes	16 bytes
Read: 033 bytes	32 bytes
Read: 065 bytes	64 bytes
Read: 128 bytes	124 bytes

The module selected defines the length of the data block that is read from the Electronic-Key and cyclically transferred to the input area. A larger data block occupies more memory in the input area of the control system.



#### Information!

If a GSD file module is replaced during communication with the control system or a parameter is changed in the module, the power supply to the modular interface adapter must then be disconnected and reconnected. The RESET button on the front of the modular interface adapter can also be used to disconnect the power supply and restart the device.

### 7.2.2 Properties for the modules for reading data

A module *EKS read* reads alarms and Electronic-Key data and writes this information to the input area of the control system.

#### 7.2.2.1 Parameter Alarm settings

Here it is defined how alarms that arise during reading are to be handled.

The following settings are possible:

- ▶ Activate diagnostics alarm
- ▶ Activate process alarm
- ▶ Deactivate alarms

#### 7.2.2.2 Parameter Start address

Here you can select a start address from the permissible memory on the Electronic-Key. Possible values on reading are byte no. 0 to byte no. 116.

#### 7.2.2.3 Parameter Number of bytes

Here you can set the number of bytes of user data to be read. This number of bytes to be read must lie in a valid memory on the Electronic-Key based on the start address. With a start address of byte no. 116, for example, the maximum number of bytes to be read is 8.



### 7.2.3 Modules available in the GSD file for writing data

The number of bytes transferred is defined by the selection of the module in the GSD file. A maximum of 116 bytes user data can be written to the Electronic-Key. The following modules can be selected:

GSD file selection (data block size) Control system output area	Electronic-Key user data write
Write: 012 bytes	8 bytes
Write: 020 bytes	16 bytes
Write: 036 bytes	32 bytes
Write: 068 bytes	64 bytes
Write: 128 bytes	116 bytes

The module selected defines the length of the data block that is written to the Electronic-Key. A larger data block occupies more memory in the output area of the control system.



#### Information!

If a GSD file module is replaced during communication with the control system or a parameter is changed in the module, the power supply to the modular interface adapter must then be disconnected and reconnected. The RESET button on the front of the modular interface adapter can also be used to disconnect the power supply and restart the device.

### 7.2.4 Properties for the modules for writing data

A module *EKS write* writes the data from the output area of the control system to the Electronic-Key.

#### 7.2.4.1 Parameter Alarm settings

Here it is defined how alarms that arise during writing are to be handled.

The following settings are possible:

- ▶ Activate diagnostics alarm
- ▶ Activate process alarm
- ▶ Deactivate alarms

### 7.3 Connecting the EKS to a PROFINET CPU

**Information!**  
 In the configuration software it is possible to integrate a single module for reading, or a single module for writing, or a module for reading and a further module for writing at the same time.

The integration of the EKS PROFINET (compact version order no. 106306) is described in the following based on the example of the TIA Portal V14 software and a Siemens CPU 1215 FC DC/DC/DC.

1. Create a new TIA project.
2. Open the project view and install the current EKS GSD file.

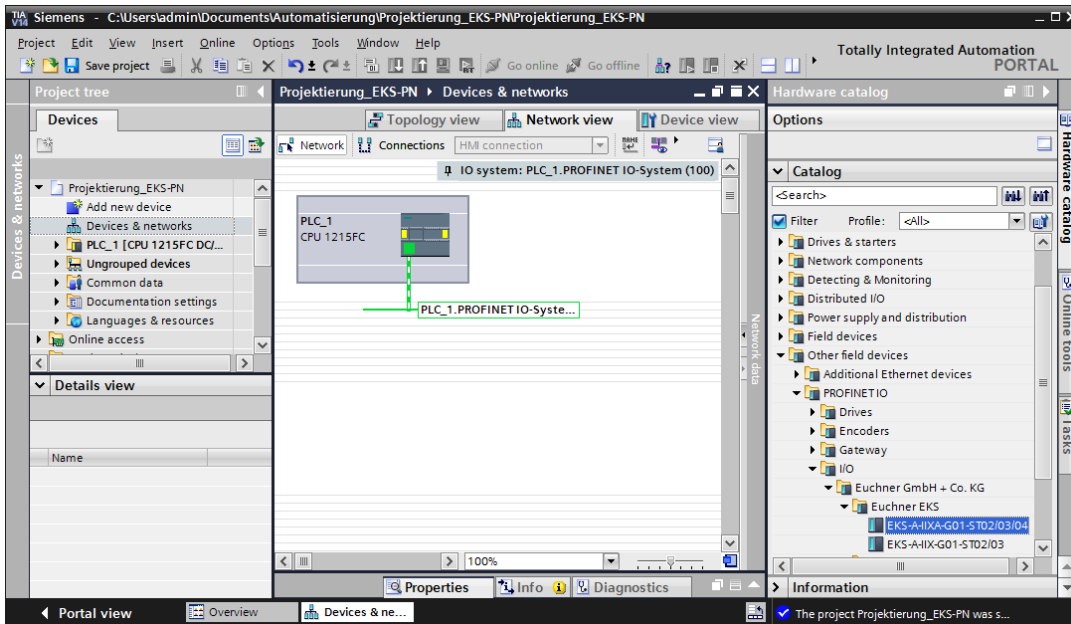

3. Select the EKS from the catalog and drag it to the PROFINET system.

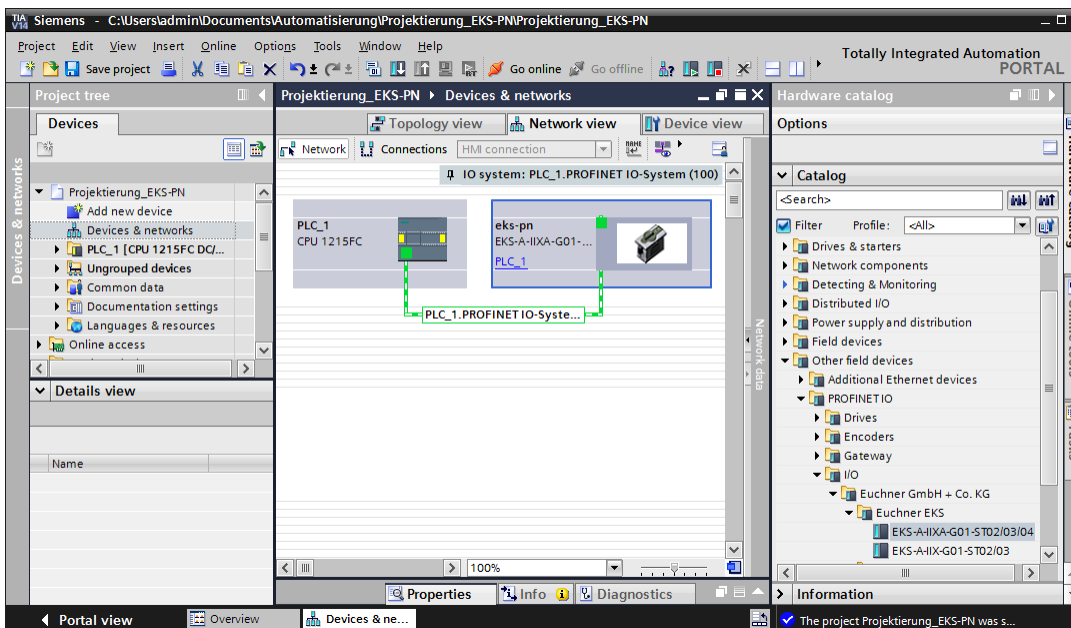

4. Select required module from GSD file

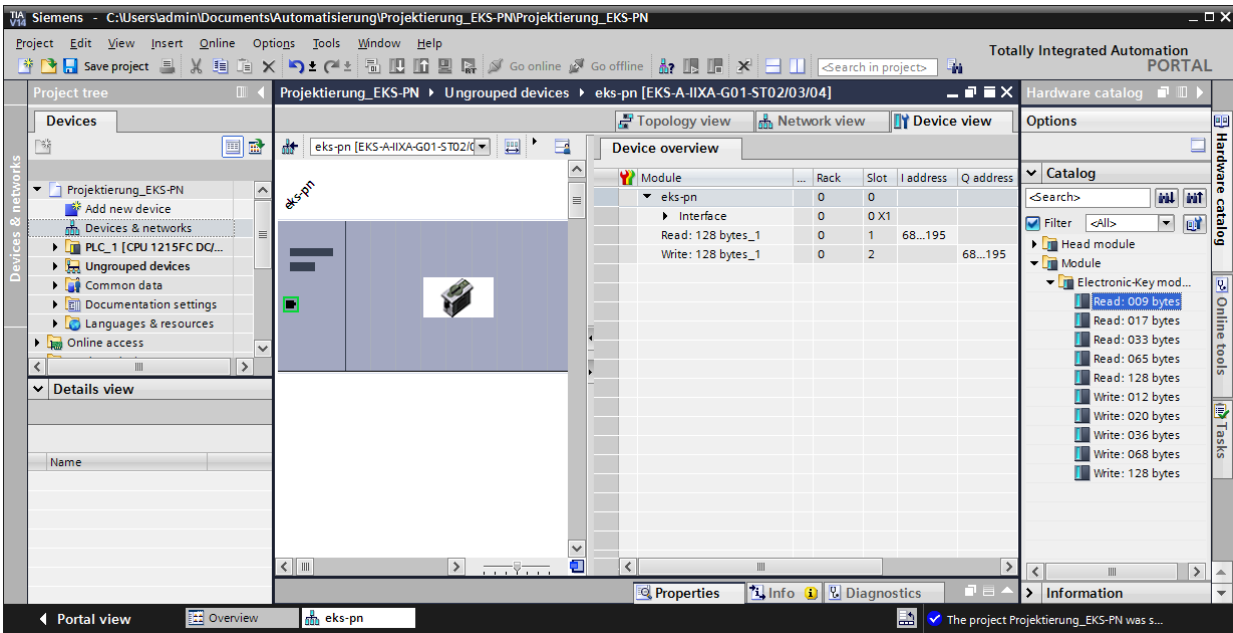

5. Make the alarm settings in the module *EKS read*.

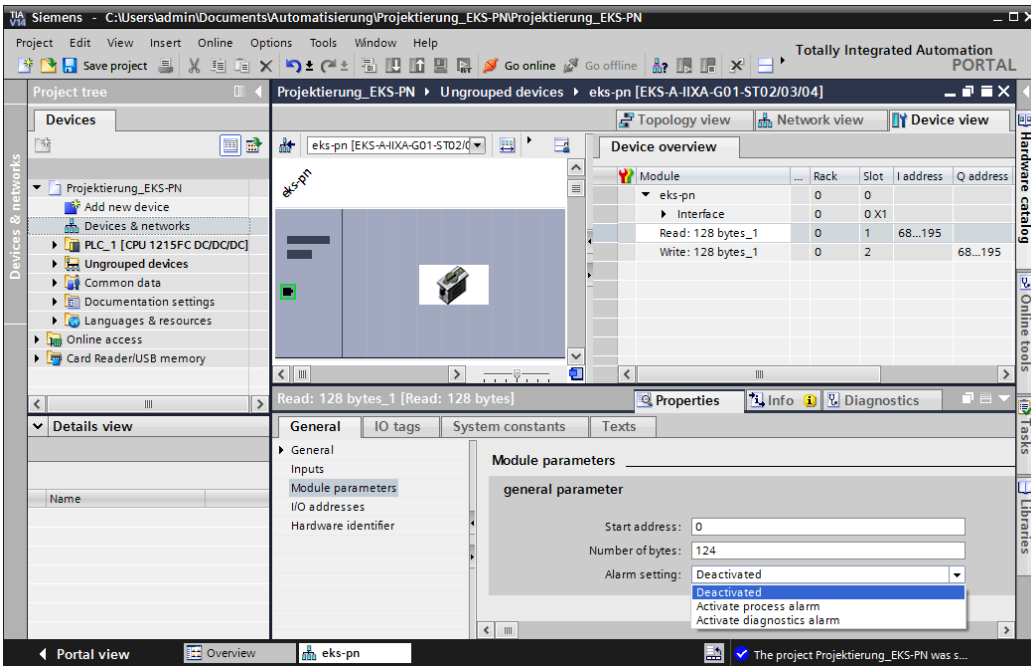

6. In the module *EKS read*, set the start address from which the data on the Electronic-Key are to be read.

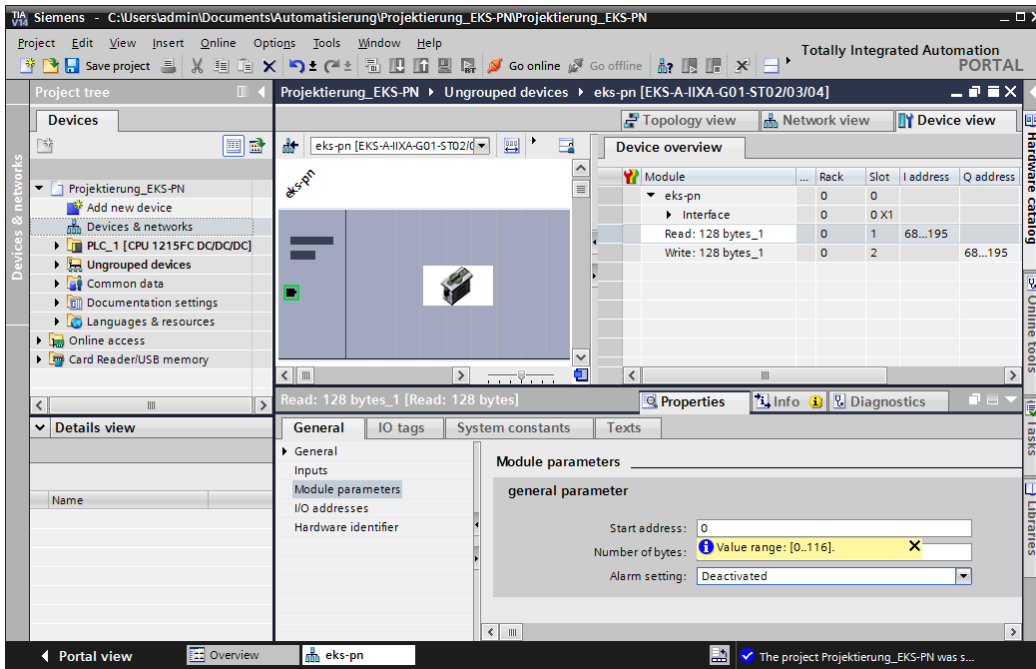

7. In the module *EKS read*, set the number of bytes to be read.

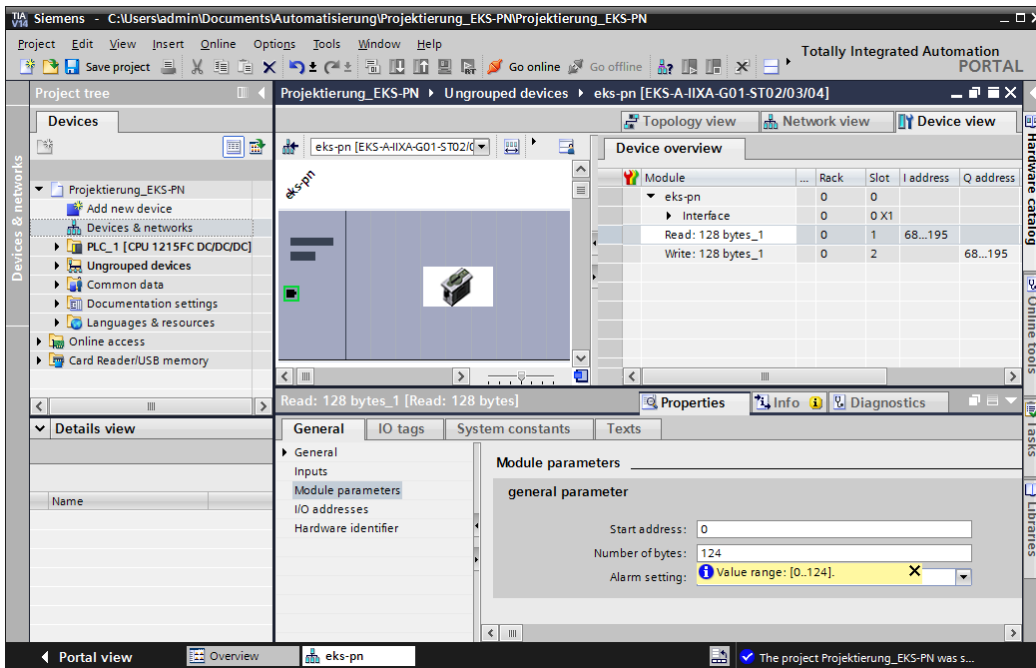

8. In the module *EKS write*, set the required alarm mode.

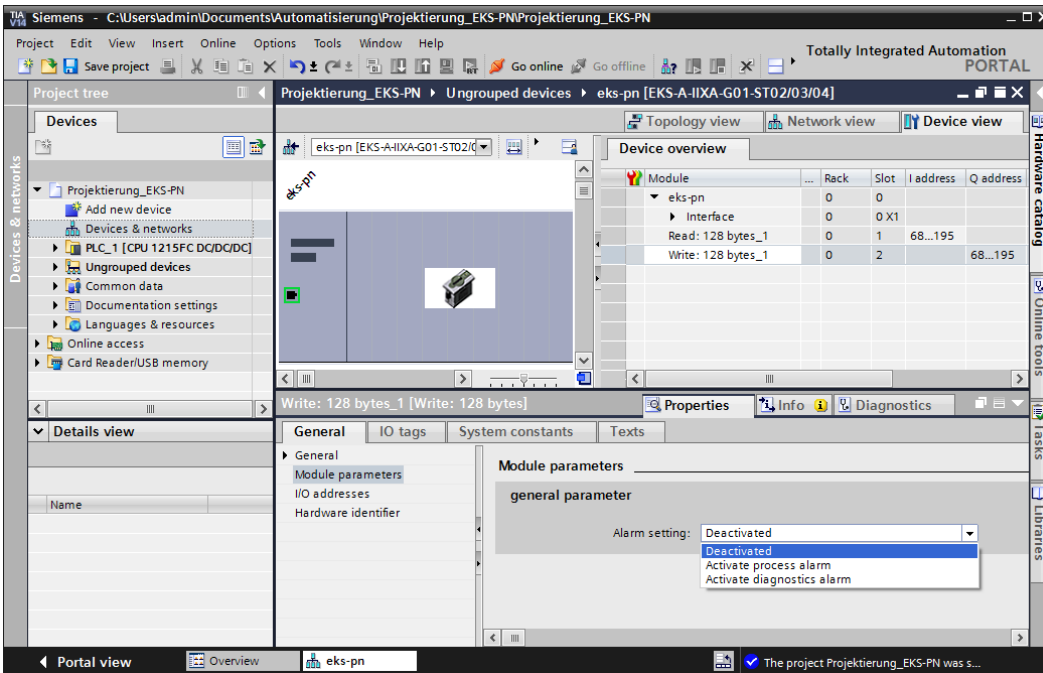

9. Configure the required name for the EKS

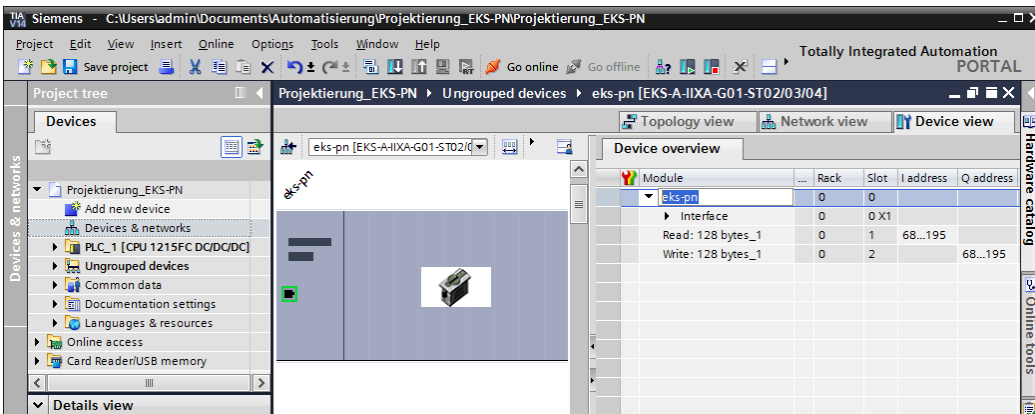

10. If required, you can change the input address area in the control system for the module *EKS read*.

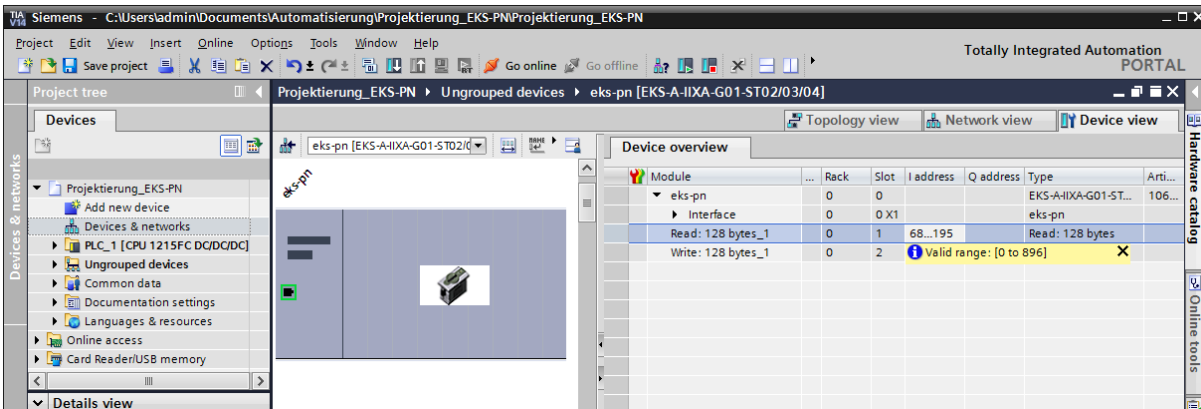

11. If required, you can change the output address area in the control system for the module *EKS write*.

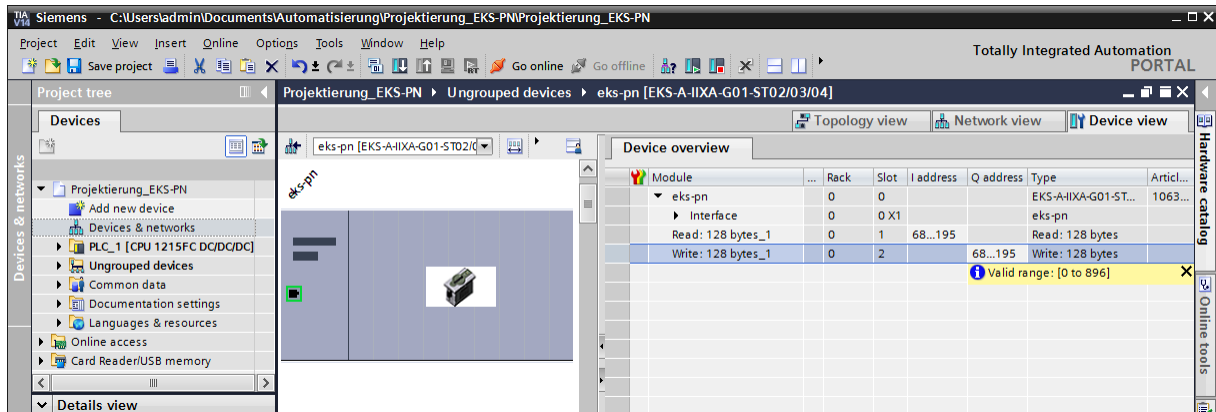

12. Save and compile your configuration. Then load it into the CPU.

- You can create your modules for the TIA project as usual and load them into the CPU.

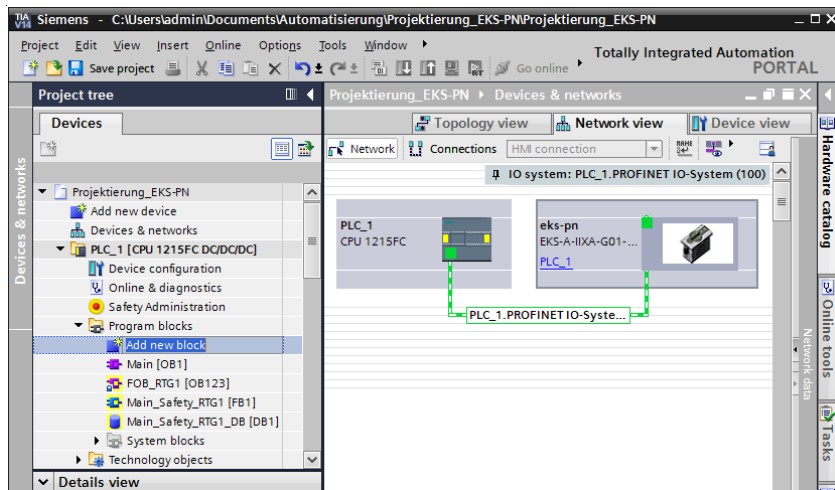

## 8 Operation in the PROFINET

### 8.1 Communication

This chapter primarily describes communication between the CPU and the read/write station (referred to as *device* in the following).

The communication between the control system and the device is either cyclic (write/read processes to and from the Electronic-Key) or acyclic (diagnostic messages).

### 8.2 EKS alarms

Depending on the setting in the configuration, the EKS can send

- ▶ Diagnostics alarms
- ▶ Process alarms
- ▶ No alarms

to the control system (see chapter 7.2 Configuration settings).

Process alarms are written to a data area in the control system. The alarms have the following structure:

[byte word with alarm no.];[byte with alarm information]

#### Example

During an attempt to read the serial number of the Electronic-Key, byte no. 116 is entered as the start address and 20 bytes as the number of bytes to be read. However, in this case the maximum possible number of bytes is 8.

Description: Error during read access. Max. number of bytes allowed incorrect.

Depiction in the related data area in the control system: 0100;08

Alarm no.	Alarm information	Description
0100 <sub>hex</sub>	Returns the max. number of bytes that are allowed to be read.	Read process terminated. Max. number of bytes allowed exceeded.
0101 <sub>hex</sub>	Returns the max. number of bytes that are allowed to be written.	Write process terminated. Max. number of bytes allowed exceeded.
0102 <sub>hex</sub>	Returns the number of bytes that has been entered incorrectly.	Write process terminated. Number of bytes is not a multiple of the block size 4.
0103 <sub>hex</sub>	Returns the start address that has been entered incorrectly.	Write process terminated. Start address is not a multiple of the block size 4.
0104 <sub>hex</sub>	Not used	Electronic-Key not in the operating distance.
0105 <sub>hex</sub>	Not used	General Electronic-Key communication error (renewed write or read necessary).
0106 <sub>hex</sub>	Not used	Write attempt despite enabled write protection. Deactivate write protection and restart device.

### 8.3 Read/write operation

In read or write operation, following successful configuration, a transfer message is continually transferred to the input area or from the output area of the control system during each I/O cycle.

The number of bytes transferred cyclically is defined by the selection of the module in the GSD file.



**Information!**

On the Electronic-Key read/write with 116 bytes freely programmable, the memory is organized in 4-byte blocks. This means the start address must be given for writing in the range byte number 0 to byte number 112, always in 4-byte steps (byte number 0, 4, 8 ... 112). Also a multiple of 4-byte sized blocks must always be written (4, 8, 12 ... 116 bytes)!

However, during reading it is possible to access the memory byte-by-byte without the above-mentioned restriction for writing.

The Electronic-Key read/write also has a unique 8-byte serial number that is permanently written to the memory during the Electronic-Key production process. The serial number can therefore not be changed. The serial number is used for secure distinction of every single Electronic-Key. It is necessary that all 8 bytes are completely evaluated for secure distinction. The serial number is appended to the freely programmable memory. The serial number can be read by entering the start address byte number 116 and the number of bytes 8.

#### 8.3.1 Input area (read process)



**Information!**

If a specific start address is not defined, the user data are cyclically transferred to the input area of the control system starting from byte no. 0 on the Electronic-Key. The number of bytes with user data transferred cyclically from the Electronic-Key depends on the setting in the configuration software for the control system (see section 7.2.2.2 Parameter Start address and 7.2.2.3 Parameter Number of bytes).

Input area of the PROFINET CPU		
Byte no.	Description	Function
0	Status byte	(see below)
1	Receive data	Max. 124 bytes user data from the Electronic-Key plus 3 bytes reserve. If fewer bytes of data were selected during configuration, these are filled with 0 <sub>hex</sub> .
⋮		
⋮		
127		

The following status information is transferred in the status byte (byte no. 0, see above):

Status byte		
Bit no.	Description (active with bit = 1)	Function
0	Device ready for operation	After successful configuration the device signals that it is ready via bit no. 0. Readiness should be continuously monitored by the application.
1	Electronic-Key detected	The detection of a valid Electronic-Key is signaled using bit no. 1. Using this bit, the application can detect that new data are available.
2	Reserve	
3		
4		
5		
6	Job finished	Bit no. 6 indicates that a write process has been successfully finished.
7	Job in progress	Bit no. 7 indicates that a write process is currently in progress.



**Information!**

It is imperative all reserve bits are set to 0.



**8.3.2 Output area (write process)**



**Information!**

When this command is used, the Electronic-Key must be in the Electronic-Key adapter, and must be removed from within the operating distance only after the reply message has been received.

As the serial number of the Electronic-Key cannot be written, the start address for the data to be written is limited to byte no. 0 to byte no. 112.

Output area of the PROFINET CPU		
Byte no.	Description	Function
0	Command byte	(see below)
1	Start address	Defines first byte in the memory of the Electronic-Key that is written on setting bit no. 0 in the command byte. Start address of user data: Byte no. 0, 4, 8 ... 112.
2	Number of bytes	Defines the number of bytes in the memory of the Electronic-Key that are written on setting bit no. 0 in the command byte. Number of bytes of user data: 4, 8, 12 ... 116 bytes.
3	Not used	
4	Transmit data	If bit no. 0 in the command byte is set to 1, the content of these bytes is written to the Electronic-Key starting from the start address defined.
⋮		
⋮		
119		
120	Not used	
⋮		
127		

In the command byte it is defined whether data are written to the Electronic-Key.

Command byte		
Bit no.	Description (active with bit = 1)	Function
0	Write Electronic-Key	After this bit is set, the content of "Transmit data" is written to the Electronic-Key in place, starting at the "Start address" and with the length "Number of bytes". On the completion of the write process, bit no. 6 in the status byte in the input area of the CPU is set. Bit no. 0 in the command byte in the output area of the CPU must then be set to 0 so that a new write process can be started.
1	Reserve	
2		
3		
4		
5		
6		
7		



**Information!**

It is imperative all reserve bits are set to 0.

## 9 Analysis and assignment of DCP name via web interface

As an alternative to communication via PROFINET, it is possible to communicate with the EKS read/write station from a PC with the aid of web browser via TCP/IP. The feature can be used, e.g., for analysis, to read data from the memory in the Electronic-Key and to display them in the browser. The DCP name of the device can also be set via the web browser (see also DIP switch settings in chapter 4.7.3).

This process is described in detail in the following sections.

### 9.1 Network settings for a configuration PC with Windows®

#### Information!

► It is assumed that you connect the PC to the EKS read/write station as shown in the following example.



- For connection, you need a (Cat 5) patch cable.
- You must first modify the network settings on the PC so that the web interface can be opened.
- Enter IP address for the PC from 192.168.1.2 to 192.168.1.254.
- Enter subnet mask for the PC as 255.255.255.0

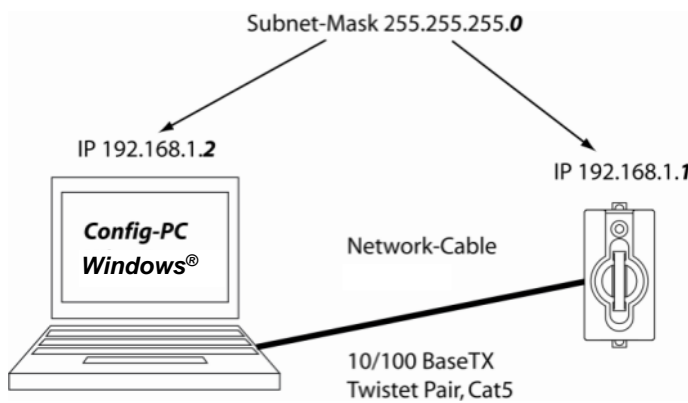
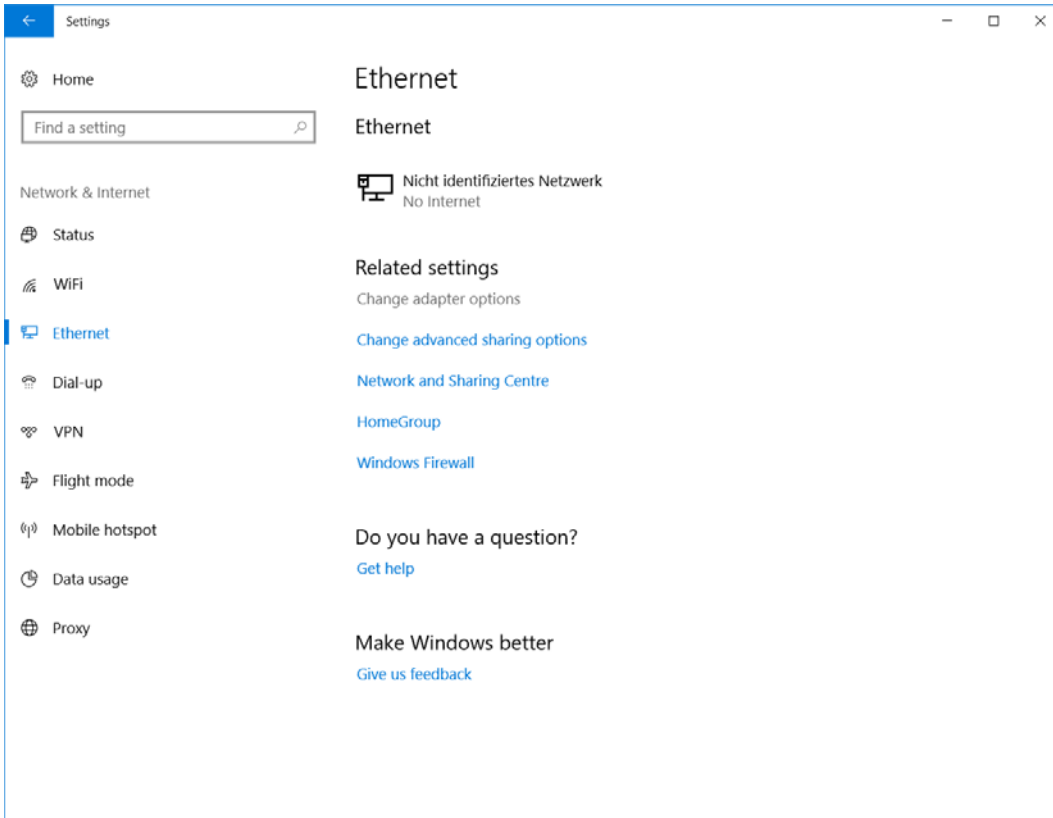

Figure 4: Configuration PC connection

### Adapting network settings

1. Select **Network & Internet** in your operating system and click **Change adapter options**.



2. Right-click **Ethernet** and then click **Properties**.

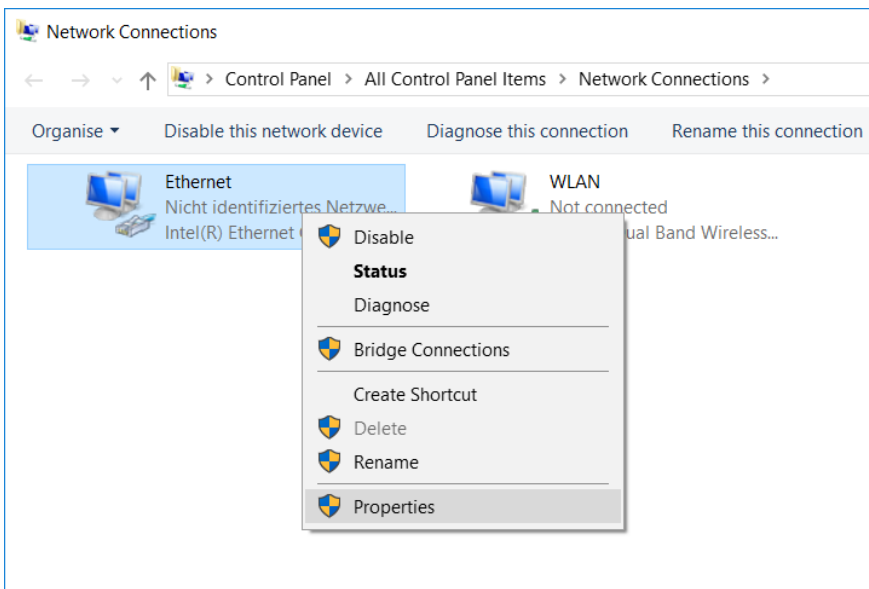

3. Open the **Properties** for **Internet Protocol Version 4 (TCP/IPv4)**.

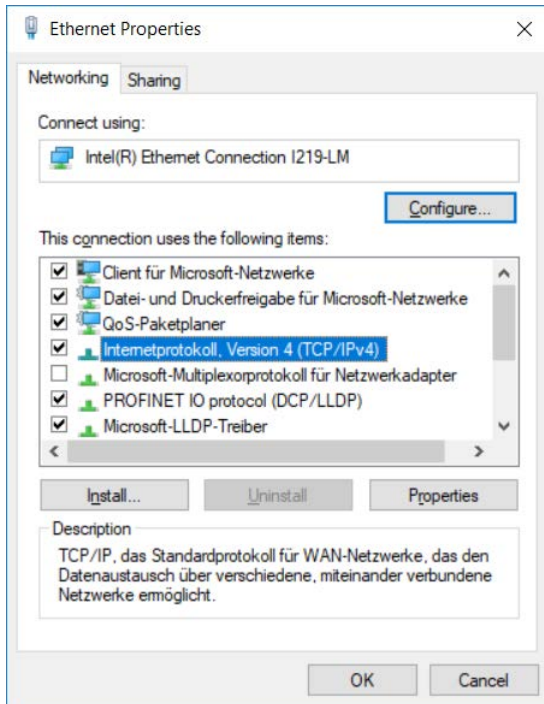

4. In order to ensure that the EKS read/write station and the configuration computer are in the same network, you must assign your configuration PC an IP address in the same subnet mask as the read/write station. On delivery, the default IP of the device is 192.168.1.1 and the subnet mask is 255.255.255.0. As a consequence you can allocate to the configuration computer, e.g. any IP address between 192.168.1.2 and 192.168.1.254. In this example, the configuration PC is assigned the IP address 192.168.1.2.

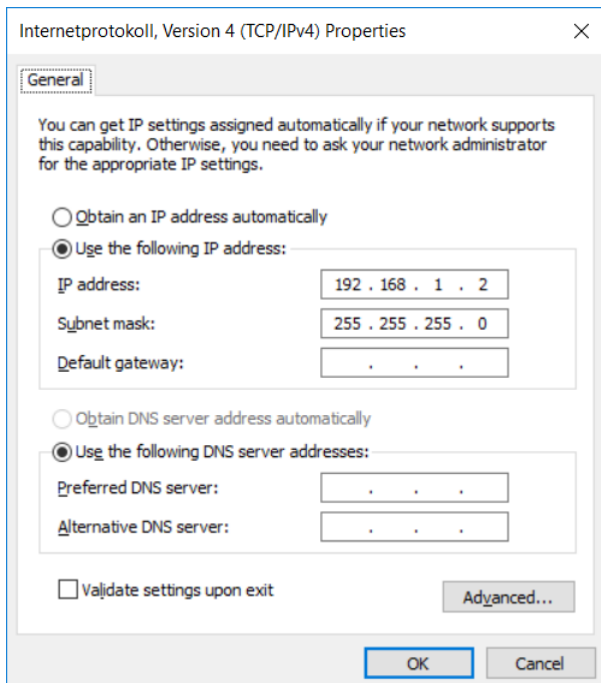

5. Click the **OK** button to confirm your entries.

The EKS read/write station can now be configured via the integrated web interface as described in chapter 9.2.

## 9.2 Configuring the read/write station via the web interface

The device can be configured with a web browser.

If you want to operate the device with a self-defined DCP name, you can configure the device using a PC. A PROFINET control system is not required during this process. This is the fastest method, particularly if several devices have to be configured. The configuration PC must meet the following requirements:

- ▶ Network card
- ▶ Web browser (e.g. Internet Explorer)
- ▶ If the configuration PC features a firewall, it may be necessary to enable the EKS read/write station as a trustworthy application. Refer to the firewall documentation for further information.

### Launching the EKS web interface

Use of the web interface is described below.



You will find the DIP switch setting for activating the web interface in chapter 4.7.3

1. Open a browser window and enter the default IP address (<http://192.168.1.1/>). If necessary, first reset the default IP address (see chapter 6.1.1.1).

- ▶ The **Information** screen of the EKS web interface is now displayed.

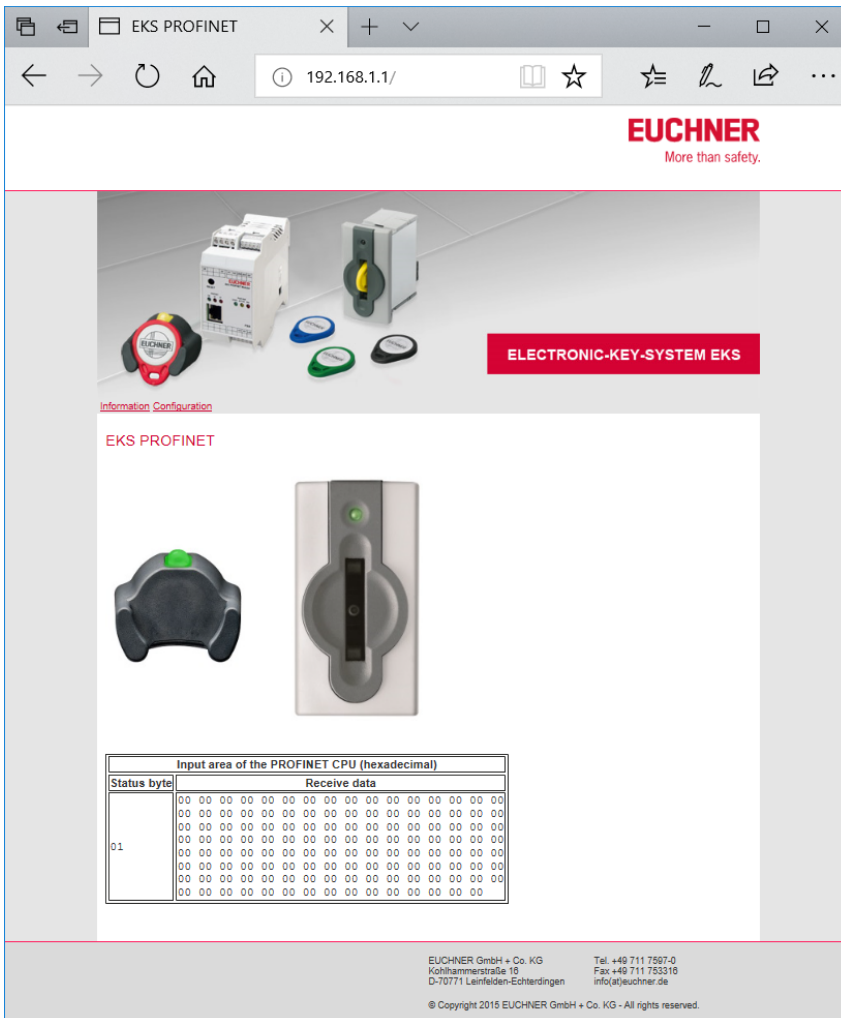

2. Click **Configuration**.

► The **Configuration** screen of the EKS web interface is now displayed.

Information Configuration

**EKS PROFINET**

Ethernet (MAC)-Address:

Firmware Version:

IP-Address:

Subnet Mask:

Gateway:

DCP-Name:

EUCHNER GmbH + Co. KG      Tel. +49 711 7597-0  
 Kohlhammerstraße 16      Fax +49 711 753316  
 D-70771 Leinfelden-Echterdingen      info(at)euchner.de

© Copyright 2015 EUCHNER GmbH + Co. KG - All rights reserved.

1. Enter the required DCP name.

2. Click the **Send** button.

► The following message is displayed: **The settings were saved, to apply settings please switch power off/on...**

3. Interrupt the power supply and connect the device again in order to adopt the settings.



#### Information!

With the modular interface adapter, the RESET button on the front can be used to disconnect the power supply and restart the device.



## 10 Exclusion of liability and warranty

In case of failure to comply with the conditions for correct use (see chapter 1.4), or if the safety instructions are not followed, or if any servicing is not performed as required, liability will be excluded and the warranty void.

## 11 Service and repair

- ▶ No servicing is required.
- ▶ Remove dirt from the key and the key adapter using a soft cloth and solvent-free, non-abrasive cleaning agents.
- ▶ Repairs are to be made only by the manufacturer.
- ▶ On version EKS *FSA* devices, the safety-related functions must be checked at regular intervals.





Microsoft Windows® is a registered  
trademark of Microsoft Corporation

EUCHNER GmbH + Co. KG  
Kohlhammerstraße 16  
70771 Leinfelden-Echterdingen

Telephone +49 711 / 75 97 - 0  
Fax +49 711 / 75 33 16  
[www.euchner.com](http://www.euchner.com) [support@euchner.de](mailto:support@euchner.de)

**EUCHNER**  
More than safety.